



NOVA line

NOVA Italia S.p.A.

Via Vecchia Scorciosa 33-35 - 66022 Fossacesia (Ch)

Tel. 0872 578934 (15 linee r.a.) - Fax 0872 57670

www.novaline.it - info@novaline.it

P.I.: 01956430696 - C.C.I.A.A. CH140833 - Capitale Sociale: € 1.100.000,00 i.v.



RAEE: IT08020000003247



Azienda con sistema

di gestione certificato

ISO 9001: 2015

Certificato N. IT 15/0141



NovaLine.it



novaline.it



novaline.it

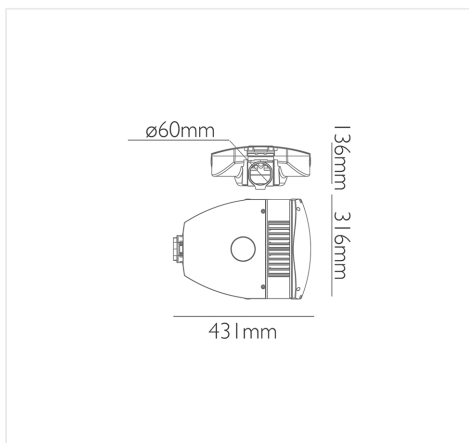

STL50K57

LAMPADA STRADALE LED PREMIUM 50 W LUCE FREDDA
5700 K, IP66

INFORMAZIONI

Marca:NOVA LINE

Materiale:Alluminio pressofuso

Altre Caratteristiche:Driver Meanwell, inclinabile 0-15°, IK10. Garanzia 7
anni

Uso:Esterno

CARATTERISTICHE ELETTRICHE

Grado di Protezione:IP66

Classe di Isolamento:I

Tensione Nominale:100-277 V

Corrente:230 mA

Fattore di Potenza:>0,95

Potenza:50 W

Temperatura di Funzionamento:-40°~50°C

Frequenza:50/60 Hz

CARATTERISTICHE ILLUMINOTECNICHE

Lumen (Lm) :8000

Tipo di Led:LUXEON 5050

Marca del Led:PHILIPS LUMILEDS

Efficienza Luminosa:160Lm/W

Temperatura di Colore:5700 K

Resa Cromatica:>70

Gradi Diffusione:110°,65°-155°,80°-160°,110°-110°

Durata in Ore (h):85000

Dimmerabile:Su Richiesta: 1-10V, PWM, potenziometrico

Tempo di innesco:istantaneo

LOGISTICA

EAN Conf.:8028274097153

Pz per Conf.:1

Tipo di Confezione:Box

Profondità Prodotto mm:136

LM-79

LM-80



CB

FC