



ELETTRICO





SPINE - PRESE
ADATTATORI

Spine

Corpo in polimero
Fermacavo a vite
Passacavo

Normative

CEI 23-50
CEI 23-121



Cod. CE10B / CE910E



Cod. CE10N / CE910NE



Cod. CE11B / CE911E



Cod. CE11N / CE911NE

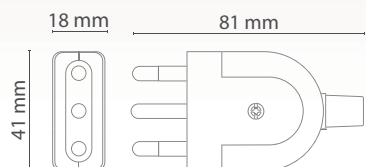

Confezionato
in box espositivo

Codice	Colore	Spina	Presca	Tensione	Confezione	Imballo/Pz	8028274
CE10B	Bianco	2 Poli + T 10A	-	250 V~	C-Box	10/100	...123708
CE10N	Nero	2 Poli + T 10A	-	250 V~	C-Box	10/100	...123715
CE910E	Bianco	2 Poli + T 10A	-	250 V~	Sfuso EAN	30/240	...123098
CE910NE	Nero	2 Poli + T 10A	-	250 V~	Sfuso EAN	30/240	...123104
CE11B	Bianco	2 Poli + T 16A	-	250 V~	C-Box	10/100	...123722
CE11N	Nero	2 Poli + T 16A	-	250 V~	C-Box	10/100	...123739
CE911E	Bianco	2 Poli + T 16A	-	250 V~	Sfuso EAN	30/240	...123111
CE911NE	Nero	2 Poli + T 16A	-	250 V~	Sfuso EAN	30/240	...123128

Spine

Corpo in polimero
Fermacavo a vite
Passacavo

Normative

CEI 23-50
CEI 23-121



Cod. CE12B



Cod. CE12N



Cod. CE16B



Cod. CE16N

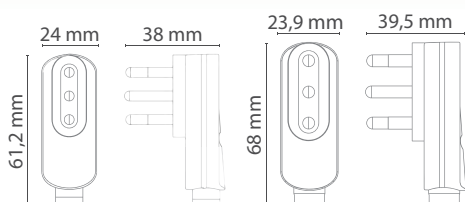

Codice	Colore	Spina	Presa	Tensione	Confezione	Imballo/Pz	8028274
CE12B	Bianco	2 Poli + T 10A	-	250 V~	Blister	10/100	...123746
CE12N	Nero	2 Poli + T 10A	-	250 V~	Busta	10/100	...123753
CE16B	Bianco	2 Poli + T 16A	-	250 V~	Blister	10/100	...123807
CE16N	Nero	2 Poli + T 16A	-	250 V~	Busta	10/100	...123814

Spine

Corpo in polimero
Fermacavo a vite
Passacavo

Normative
CEI 23-50
CEI 23-121



Cod. CE212B



Cod. CE212N



Cod. CE216B



Cod. CE216N

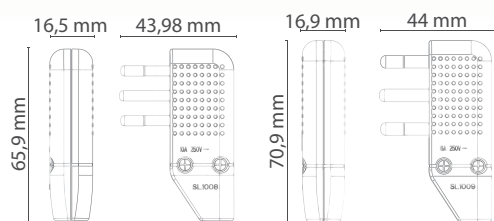

Codice	Colore	Spina	Presca	Tensione	Confezione	Imballo/Pz	8028274
CE212B	Bianco	2 Poli + T 10A	-	250 V~	C-Box	10/100	...124125
CE212N	Nero	2 Poli + T 16A	-	250 V~	C-Box	10/100	...124132
CE216B	Bianco	2 Poli + T 10A	-	250 V~	C-Box	10/100	...124149
CE216N	Nero	2 Poli + T 16A	-	250 V~	C-Box	10/100	...124156

Prese

Corpo in polimero
Fermacavo a vite
Passacavo

Normative

CEI 23-50
CEI 23-121



Cod. CE44B



Cod. CE44N



Cod. CE15B / CE915E



Cod. CE15N / CE915NE

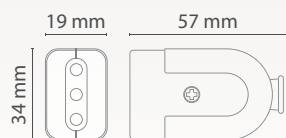

Confezionato
in box espositivo

Codice	Colore	Spina	Pres	Tensione	Confezione	Imballo/Pz	8028274
CE44B	Bianco	-	10A + T	250 V~	C-Box	10/100	...123760
CE44N	Nero	-	10A + T	250 V~	C-Box	10/100	...123777
CE15B	Bianco	-	10/16A + T	250 V~	C-Box	10/100	...123784
CE15N	Nero	-	10/16A + T	250 V~	C-Box	10/100	...123791
CE915E	Bianco	-	10/16A + T	250 V~	Sfuso EAN	30/240	...123166
CE915NE	Nero	-	10/16A + T	250 V~	Sfuso EAN	30/240	...123173

Spine e Prese

Corpo in polimero
Fermacavo a vite
Passacavo

Normative
CEI 23-50
CEI 23-121



KIT
Cod. CE27B



KIT
Cod. CE28B



KIT
Cod. CE27N



KIT
Cod. CE28N

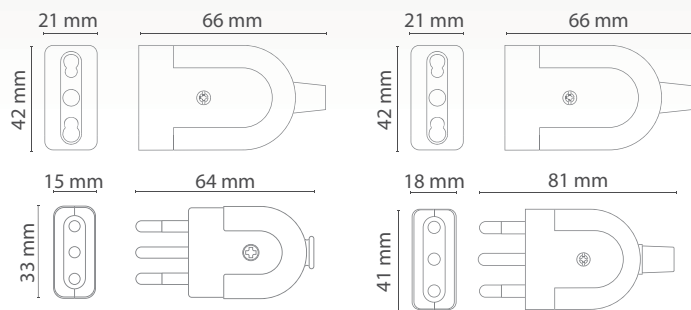

Codice	Colore	Spina	Presca	Tensione	Confezione	Imballo/Pz	8028274
CE27B	Bianco	2 Poli + T 10A	10/16A + T	250 V~	C-Box	10/100	...123821
CE27N	Nero	2 Poli + T 10A	10/16A + T	250 V~	C-Box	10/100	...123838
CE28B	Bianco	2 Poli + T 16A	10/16A + T	250 V~	C-Box	10/100	...123845
CE28N	Nero	2 Poli + T 16A	10/16A + T	250 V~	C-Box	10/100	...123852

Spine e Prese

Corpo in polimero
Fermacavo a vite
Passacavo

Normative

CEI 23-50
CEI 23-121



Cod. CE36B / CE36E



Cod. CE36N / 36NE



Cod. CE45B / CE45E



Cod. CE45N / CE45NE

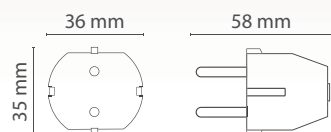
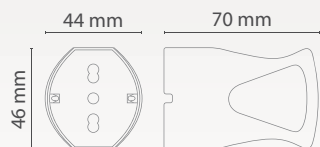

Confezionato
in box espositivo

Codice	Colore	Spina	Presca	Tensione	Confezione	Imballo/Pz	8028274
CE36B	Bianco	-	Schuko 10/16A + T	250 V~	C-Box	10/90	...123661
CE36N	Nero	-	Schuko 10/16A + T	250 V~	C-Box	10/90	...123678
CE36E	Bianco	-	Schuko 10/16A + T	250 V~	Sfuso EAN	25/200	...123050
CE36NE	Nero	-	Schuko 10/16A + T	250 V~	Sfuso EAN	25/200	...123067
CE45B	Bianco	Schuko 2 Poli+T 16A	-	250 V~	C-Box	10/90	...123685
CE45N	Nero	Schuko 2 Poli+T 16A	-	250 V~	C-Box	10/90	...123692
CE45E	Bianco	Schuko 2 Poli+T 16A	-	250 V~	Sfuso EAN	25/200	...123074
CE45NE	Nero	Schuko 2 Poli+T 16A	-	250 V~	Sfuso EAN	25/200	...123081

Adattatori

Corpo in polimero

Normative

CEI 23-57



Cod. CE480B



Cod. CE480N

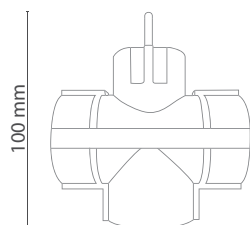
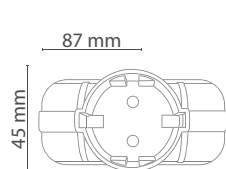

Codice	Colore	Spina	Presa	Tensione	Confezione	Imballo/Pz	8028274
CE480B	Bianco	Schuko	3 x Schuko	250 V~	C-Box	10/80	...123906
CE480N	Nero	Schuko	3 x Schuko	250 V~	C-Box	10/80	...123913

Adattatori

Corpo in polimero

Normative
CEI 23-57



Cod. CE47B



Cod. CE47N

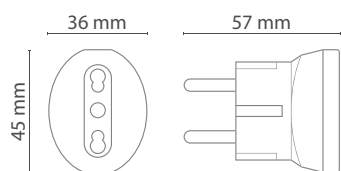

Codice	Colore	Spina	Presa	Tensione	Confezione	Imballo/Pz	8028274
CE47B	Bianco	Schuko	10/16A + T	250 V~	C-Box	10/90	...123883
CE47N	Nero	Schuko	10/16A + T	250 V~	C-Box	10/90	...123890

Adattatori multipli

Corpo in polimero

Normative

CEI 23-57



Cod. CE49B



Cod. CE49N

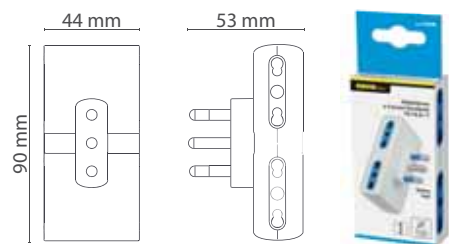

Codice	Colore	Spina	Presa	Tensione	Confezione	Imballo/Pz	8028274
CE49B	Bianco	2 Poli + T 16A	4x10/16A + T	250 V~	C-Box	10/100	...123869
CE49N	Nero	2 Poli + T 16A	4x10/16A + T	250 V~	C-Box	10/100	...123876

Adattatori

Corpo in polimero

Normative
CEI 23-57



Cod. CE13B / CE913E



Cod. CE13N / CE913NE



Cod. CE17B / CE917E



Cod. CE17N / CE917NE

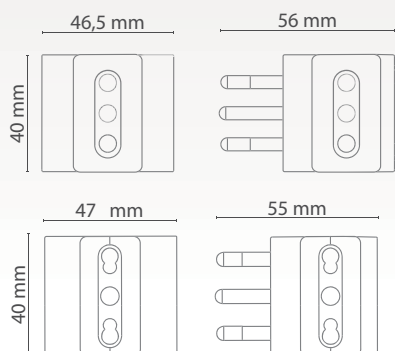

Confezionato
in box espositivo

Codice	Colore	Spina	Presca	Tensione	Confezione	Imballo/Pz	8028274
CE13B	Bianco	2 Poli + T 10A	3x2 Poli + T 10A	250 V~	C-Box	10/120	...123920
CE13N	Nero	2 Poli + T 10A	3x2 Poli + T 10A	250 V~	C-Box	10/120	...123937
CE913E	Bianco	2 Poli + T 10A	3x2 Poli + T 10A	250 V~	Sfuso EAN	30/240	...123135
CE913NE	Nero	2 Poli + T 10A	3x2 Poli + T 10A	250 V~	Sfuso EAN	30/240	...123142
CE17B	Bianco	2 Poli + T 16A	3x2 Poli + T 10/16A	250 V~	C-Box	10/120	...123968
CE17N	Nero	2 Poli + T 16A	3x2 Poli + T 10/16A	250 V~	C-Box	10/120	...123975
CE917E	Bianco	2 Poli + T 16A	3x2 Poli + T 10/16A	250 V~	Sfuso EAN	30/240	...123180
CE917NE	Nero	2 Poli + T 16A	3x2 Poli + T 10/16A	250 V~	Sfuso EAN	30/240	...123197

Adattatori

Corpo in polimero

Normative
CEI 23-57



Cod. CE37B / CE37E



Cod. CE37N / CE937NE



Cod. CE38B / CE938E



Cod. CE38N / CE938NE

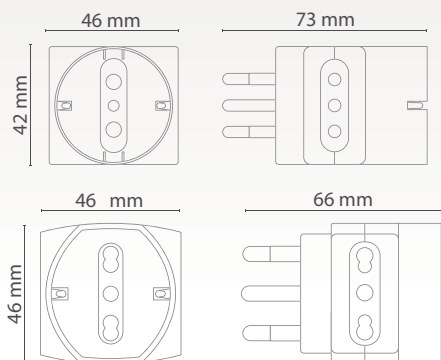

Confezionato
in box espositivo

Codice	Colore	Spina	Presca	Tensione	Confezione	Imballo/Pz	8028274
CE37B	Bianco	2 Poli + T 10A	2x2 Poli + T 10A, 1xSchuko	250 V~	C-Box	10/100	...124002
CE37N	Nero	2 Poli + T 10A	2x2 Poli + T 10A, 1xSchuko	250 V~	C-Box	10/100	...011654
CE937E	Bianco	2 Poli + T 10A	2x2 Poli + T 10A, 1xSchuko	250 V~	Sfuso EAN	25/200	...122367
CE937NE	Nero	2 Poli + T 10A	2x2 Poli + T 10A, 1xSchuko	250 V~	Sfuso EAN	25/200	...123210
CE38B	Bianco	2 Poli + T 16A	2x2 Poli + T 10/16A, 1xSchuko	250 V~	C-Box	10/100	...124026
CE38N	Nero	2 Poli + T 16A	2x2 Poli + T 10/16A, 1xSchuko	250 V~	C-Box	10/100	...011661
CE938E	Bianco	2 Poli + T 16A	2x2 Poli + T 10/16A, 1xSchuko	250 V~	Sfuso EAN	25/200	...121605
CE938NE	Nero	2 Poli + T 16A	2x2 Poli + T 10/16A, 1xSchuko	250 V~	Sfuso EAN	25/200	...123227

Adattatori

Corpo in polimero

Normative
CEI 23-57



Cod. CE14B / CE914E



Cod. CE14N / CE914NE



Cod. CE18B / CE918E



Cod. CE18N / CE918NE

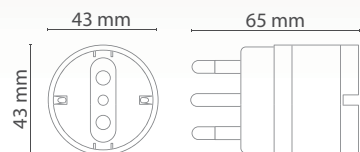
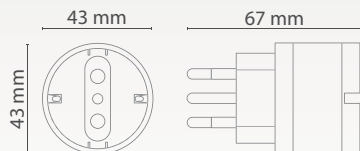

Confezionato
in box espositivo

Codice	Colore	Spina	Presa	Tensione	Confezione	Imballo/Pz	8028274
CE14B	Bianco	2 Poli + T 10A	Schuko	250 V~	C-Box	30/240	...123944
CE14N	Nero	2 Poli + T 10A	Schuko	250 V~	C-Box	30/240	...011678
CE914E	Bianco	2 Poli + T 10A	Schuko	250 V~	Sfuso EAN	30/240	...121582
CE914NE	Nero	2 Poli + T 10A	Schuko	250 V~	Sfuso EAN	30/240	...123159
CE18B	Bianco	2 Poli + T 16A	Schuko	250 V~	C-Box	30/240	...123982
CE18N	Nero	2 Poli + T 16A	Schuko	250 V~	C-Box	30/240	...123999
CE918E	Bianco	2 Poli + T 16A	Schuko	250 V~	Sfuso EAN	30/240	...121599
CE918NE	Nero	2 Poli + T 16A	Schuko	250 V~	Sfuso EAN	30/240	...123203

Adattatori salvaspazio

Corpo in polimero

Normative

CEI 23-57



Cod. CE214B



Cod. CE214N



Cod. CE238B



Cod. CE238N

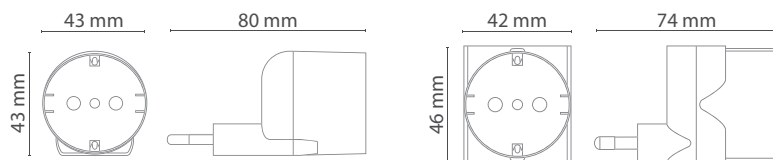

Codice	Colore	Spina	Presa	Tensione	Confezione	Imballo/Pz	8028274
CE214B	Bianco	2 Poli + T 10A	1xSchuko	250 V~	C-Box	10/100	...124187
CE214N	Nero	2 Poli + T 10A	1xSchuko	250 V~	C-Box	10/100	...124194
CE238B	Bianco	2 Poli + T 16A	1xSchuko, 2x10/16A + T	250 V~	C-Box	10/100	...124200
CE238N	Nero	2 Poli + T 16A	1xSchuko, 2x10/16A + T	250 V~	C-Box	10/100	...124217

Adattatori

Adattatore con USB

Corpo in polimero bianco
Porta USB 5 V, 2100 mA

Normative

CEI 23-122

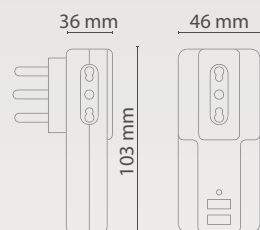

USB
2100mA



Codice	Spina	USB	Prese	Tensione	Confezione	Imballo/Pz	8028274
CE217USB	2 Poli+T 16A	2 porte DC 5Vx2,1A	3x10/16A+T	250 V~	C-Box	10/120	...107920

Adattatore con protezione da sovraccarico

Interruttore Reset luminoso

Spina 10A + T

Alveoli protetti

3 prese: 1 Schuko bivalente - 2 bivalenti

Corpo in polimero bianco

Normative

CEI 23-122



Protezione sovraccarico con Reset



Spina 10A

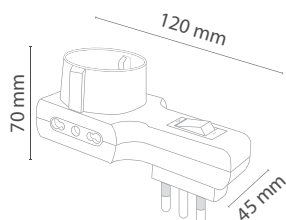

Codice	Spina	Interruttore	Uscite	Tensione	Confezione	Imballo/Pz	8028274
CE290	2 Poli+T 10A	Prot. sovrac.	2x10/16A+T, 1xSchuko 10/16A+T	250 V~	C-Box	10/100	...107050

Adattatori da viaggio

Multistandard
in policarbonato

Normative
CEI 23-57

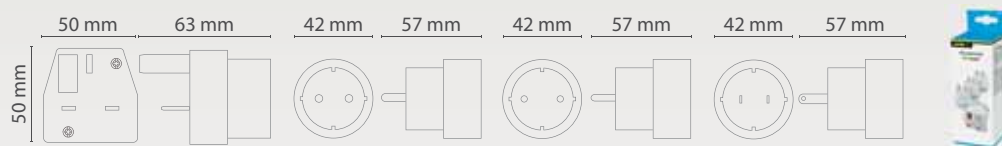

Codice	Spina	Prese	Tensione	Confezione	Imballo/Pz	8028274
CE62	EU, UK, USA, Australia	EU, UK, USA, Australia	250 V~	Scatola	10/60	...011319



Adattatori da viaggio

Multistandard in ABS
2 porte USB 2400mA
Potenza massima applicabile:
1380W a 220V

Normative
CEI 23-57

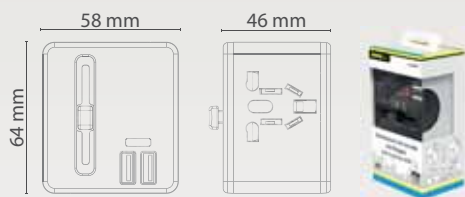

Codice	Spina	Prese	Potenza	Tensione	USB	Conf.	Imballo/Pz	8028274
CE682	EU, UK, USA, AUS	EU, UK, USA, AUS	1380W a 230V/660W a 110V	100-240 V~	2USB 2.4A	Scatola	1/50	...107692

Multistandard in ABS
Potenza massima applicabile:
1840W a 220V

Normative
CEI 23-57

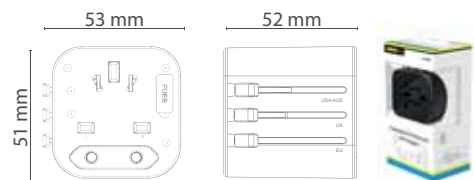

Codice	Spina	Prese	Potenza	Tensione	Confezione	Imballo/Pz	8028274
CE282	EU, UK, USA, AUS	EU, UK, USA, AUS	1840W a 230V/880W a 110V	100-240 V~	Scatola	1/50	...107029

Presa Energy Saving

Elimina gli Stand-By
 2 interruttori ON/OFF manuali
 1 Ricevitore ON/OFF infrarossi

Normative

CEI 23-50
 CEI 23-121



Codice	Spina	Presca	Portata massima	Tensione	Confezione	Imballo/Pz	8028274
CE222	2 Poli+T 16A	10/16A+T	2200W	250 V~	Blister	10/100	...019254





MULTIPRESE

Multiprese Bivalenti

Alveoli protetti
Cavo 1,5 m H05VV-F 3G1.0 mm²
Corpo in polimero bianco

Normative

CEI 23-50
CEI 23-122



Cod. CE904
Cod. CE904C
Cod. CE904E



Cod. CE950
Cod. CE950C

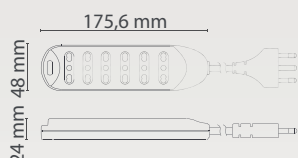
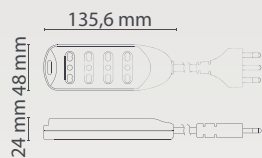

Codice	Spina	Presa	Tensione	Confezione	Imballo/Pz	8028274
CE904	2 Poli + T 16A	4 x 10/16A + T	250 V~	Blister	1/10	...100525
CE904C	2 Poli + T 16A	4 x 10/16A + T	250 V~	Busta	1/25	...013467
CE904E	2 Poli + T 16A	6 x 10/16A + T	250 V~	Scatola	8/32	...121612
CE950	2 Poli + T 16A	6 x 10/16A + T	250 V~	Blister	1/10	...100518
CE950C	2 Poli + T 16A	6 x 10/16A + T	250 V~	Busta	1/25	...013474

Interruttore ON/OFF luminoso
Alveoli protetti
Cavo 1,5 m H05VV-F 3G1.0 mm²
Corpo in polimero bianco

Normative

CEI 23-50
CEI 23-122



Cod. CE110/4C



Cod. CE110/6C

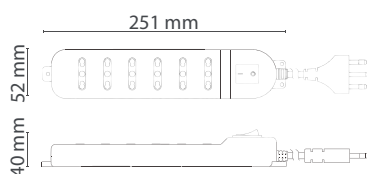
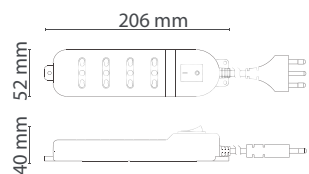

Codice	Spina	Presa	Tensione	Confezione	Imballo/Pz	8028274
CE110/4C	2 Poli + T 16A	4 x 10/16A + T	250 V~	Busta	1/25	...019438
CE110/6C	2 Poli + T 16A	6 x 10/16A + T	250 V~	Busta	1/25	...019025

Multiprese Bivalente senza cavo

Presa multipla a 6 uscite bivalenti 10/16A
Max 2500W
Corpo in polimero bianco

Normative

CEI 23-50
CEI 23-122

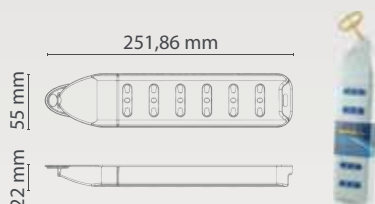

Codice	Spina	Uscite	Tensione	Confezione	Imballo/Pz	8028274
CE550	-	6 x 10/16A	250 V~	Blister	1/40	...120806

Multipresa Bivalente Slim

Cavo 1,5 m H05VV-F 3G1.0 mm²
Corpo in polimero bianco

Normative

CEI 23-50
CEI 23-122



Particolarmente adatta per spazi ristretti come il retro dei mobili

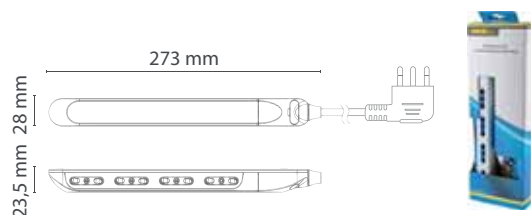

Codice	Spina	Presca	Tensione	Confezione	Imballo/Pz	8028274
CEW04S	16A - 90°	4 x 10/16A	250 V~	Blister	1/24	...119695

Multiprese Polivalenti

Interruttore ON/OFF luminoso
Alveoli protetti
Cavo 1,5 m H05VV-F 3G1.0 mm²
Corpo in polimero bianco

Normative

CEI 23-50
CEI 23-122



Cod. CE31/3
Cod. CE31/3C



Cod. CE31/4
Cod. CE31/4C



Cod. CE31/5
Cod. CE31/5C



Cod. CE31/6
Cod. CE31/6C

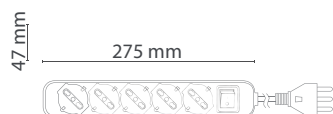

Codice	Spina	Uscite	Tensione	Confezione	Imballo/Pz	8028274
CE31/3C	2 Poli + T 16A	3 x Schuko 10/16A+T	250 V~	Busta	1/25	...112955
CE31/4C	2 Poli + T 16A	4 x Schuko 10/16A+T	250 V~	Busta	1/25	...012361
CE31/5C	2 Poli + T 16A	5 x Schuko 10/16A+T	250 V~	Busta	1/25	...012149
CE31/6C	2 Poli + T 16A	6 x Schuko 10/16A+T	250 V~	Busta	1/25	...012354

Multiprese Polivalenti

Interruttore ON/OFF luminoso
Alveoli protetti
Cavo 1,5 m H05VV-F 3G1.0 mm²
Corpo in polimero bianco

Normative

CEI 23-50
CEI 23-122



Cod. CE31/3NC

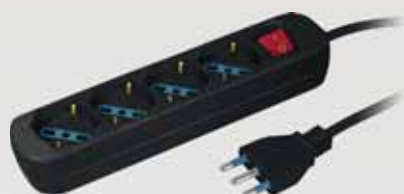

Cod. CE31/4NC



Cod. CE31/5NC



Cod. CE31/6NC

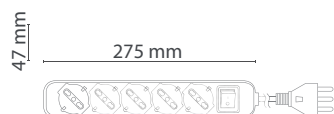

Codice	Spina	Uscite	Tensione	Confezione	Imballo/Pz	8028274
CE31/3NC	2 Poli + T 16A	3 x Schuko 10/16A+T	250 V~	Busta	1/25	...125542
CE31/4NC	2 Poli + T 16A	4 x Schuko 10/16A+T	250 V~	Busta	1/25	...125559
CE31/5NC	2 Poli + T 16A	5 x Schuko 10/16A+T	250 V~	Busta	1/30	...125566
CE31/6NC	2 Poli + T 16A	6 x Schuko 10/16A+T	250 V~	Busta	1/25	...125573

Multiprese Polivalenti

Interruttore ON/OFF luminoso
 Cavo 1,5 m H05VV-F 3G1.0 mm²
 Corpo in polimero bianco

Normative

CEI 23-50
 CEI 23-122



CED04P



CED06P

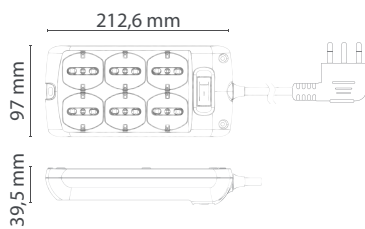
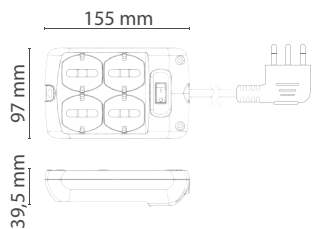

Codice	Spina	Uscite	Tensione	Confezione	Imballo/Pz	8028274
CED04P	16A - 90°	4 x Schuko 10/16A	250 V~	Blister	1/24	...119671
CED06P	16A - 90°	6 x Schuko 10/16A	250 V~	Blister	1/24	...119688

Multiprese Polivalenti

Interruttore ON/OFF luminoso
Interruttori su singola presa
Cavo 1,5 m H05VV-F 3G1.0 mm²
Corpo in polimero bianco

Normative

CEI 23-50

CEI 23-122

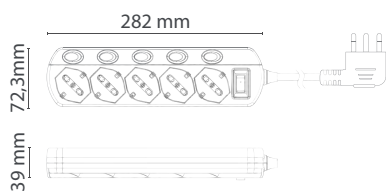

Codice	Spina	Uscite	Tensione	Confezione	Imballo/Pz	8028274
CEK05Y	16A-90°	5xSchuko/10/16A	250 V~	Blister	1/24	...119664

Multiprese con protezione

Multipresa con protezione da sovraccarico
Interruttore Reset luminoso
Spina 10A + T
Alveoli protetti
5 prese Schuko - bivalenti
Cavo 1,5 m H05VV-F 3G1.0mm²
Corpo in polimero nero

Normative

CEI 23-50
CEI 23-122

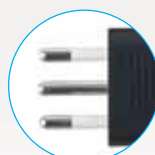

Spina 10A

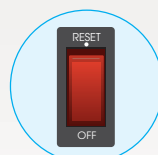

Protezione
sovraccarico
con Reset



Codice	Spina	Interruttore	Uscite	Tensione	Confezione	Imballo/Pz	8028274
CE231/5PKC	2 Poli+T 10A	Prot. sovrac.	5xSchuko 10/16A+T	250 V~	Shrink Pack	1/25	...109023

Multipresa con protezione

Multipresa con protezione da sovraccarico
Interruttore Reset luminoso
Spina 10A + T
Alveoli protetti
12 prese: 4 Schuko - bivalenti / 8 bivalenti
Cavo 1,5 m H05VV-F 3G1.0mm²
Corpo in polimero nero

Normative

CEI 23-50
CEI 23-122

12 prese

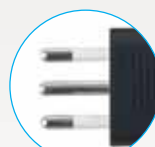

Spina 10A

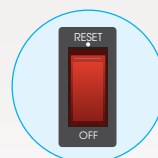

Protezione sovraccarico con Reset

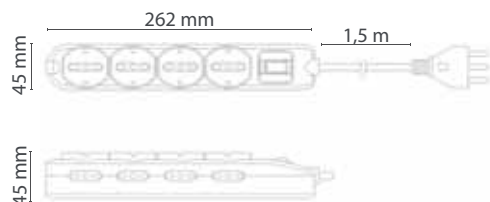

Codice	Spina	Interruttore	Uscite	Tensione	Confez.	Imballo/Pz	8028274
CE274/4PK	2 Poli+T 10A	Prot. sovrac.	8x10/16A+T, 4xSchuko 10/16A+T	250 V~	Blister	6/36	...107043

Multiprese Polivalenti

Interruttore ON/OFF luminoso
 Alveoli protetti
 Cavo 1,5 m H05VV-F 3G1.0 mm²
 Corpo in polimero bianco

Normative

CEI 23-50
 CEI 23-122



Cod. CE74/2
 Cod. CE74/2C



Cod. CE74/3
 Cod. CE74/3C



Cod. CE74/4
 Cod. CE74/4C

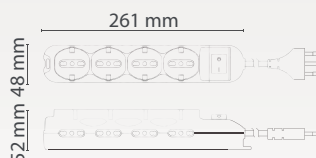
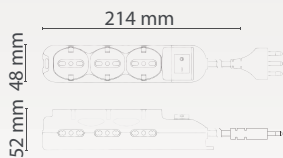
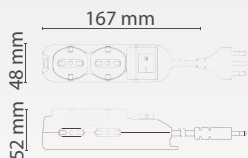

Codice	Spina	Uscite	Tensione	Confezione	Imballo/Pz	8028274
CE74/2C	2 Poli + T 16A	4x10/16A+T, 2xSchuko 10/16A+T	250 V~	Busta	1/25	...019094
CE74/3C	2 Poli + T 16A	6x10/16A+T, 3xSchuko 10/16A+T	250 V~	Busta	1/25	...019117
CE74/4C	2 Poli + T 16A	8x10/16A+T, 4xSchuko 10/16A+T	250 V~	Busta	1/25	...019131

Multipresa Polivalente senza cavo

Presca multipla a 4 uscite bivalenti 10/16A
2 uscite bivalenti Schuko
Max 2500W
Corpo in polimero bianco

Normative

CEI 23-50
CEI 23-122

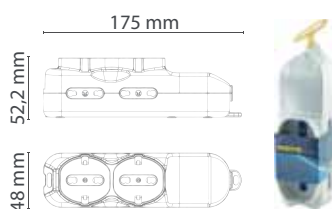

Codice	Spina	Uscite	Tensione	Confezione	Imballo/Pz	8028274
CE574	-	4 x 10/16A + 2 x Schuko 10/16A	250 V~	Blister	1/40	...120790

Multiprese con USB

Porta USB 5 V, 2400 mA
Interruttore ON/OFF luminoso
Alveoli protetti
Cavo H05VV-F 3G1.0 mm²
Corpo in polimero nero

Normative

CEI 23-50
CEI 23-122

USB
2400mA

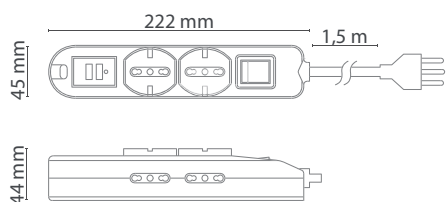

Codice	Spina	Interr.	USB	Uscite	Tensione	Confez.	Imballo/Pz	8028274
CE74/2USB	2Poli+T 16A	on/off	2 x 2,4A	2 Schuko Trival. + 4 Bip. 10/16A+T	250 V~	Blister	6/36	...107937

MULTIPRESE con USB

Multipresa con protezione da sovraccarico
 Interruttore Reset luminoso
 3 porte USB (2 Type-A - 1 Type-C) 2.1A max
 Cavo 5 cm
 Spina 10A 90°
 Corpo in polimero bianco

Normative

CEI 23-50
 CEI 23-122



Cod. CE650USB

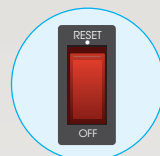

Protezione
sovraccarico
con Reset

3x **USB**
2100mA



Cod. CE680USB

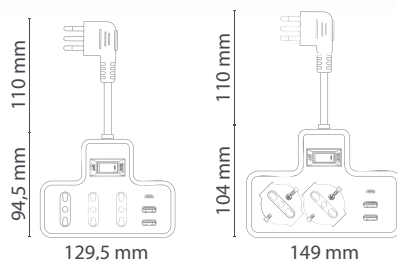

Codice	Spina	Interr.	USB	Uscite	Tensione	Confez.	Imballo/Pz	8028274
CE650USB	2 Poli+T 10A	on/off/Reset	3 x 2,1A	3 x Bip. 10/16A+T	250 V~	Scatola	10/30	...120745
CE680USB	2 Poli+T 10A	on/off/Reset	3 x 2,1A	2 x Schuko Trival.	250 V~	Scatola	10/30	...120745

Multipresa Polivalente da tavolo

Multipresa da tavolo a 6 uscite:
4 bivalenti 10/16A, 2 Shuko bivalenti.
Spina 2 poli + T 16A 90°
Max 3500W 250V
Lunghezza cavo 1,5m
Sezione cavo \varnothing 3x1 mm²
Colore bianco

Normative

CEI 23-50
CEI 23-122

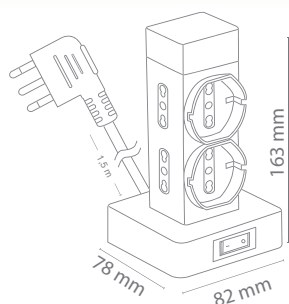

Codice	Spina	Interr.	Uscite	Tensione	Confez.	Imballo/Pz	8028274
CE360	2 Poli+T 16A 90°	on/off	2xSchuko Bival. + 4xBip. 10/16A+T	250 V~	Shrink Pack	1/20	...121780

MULTIPRESE da tavolo con USB

Da tavolo, con interruttore di sicurezza
 3 porte USB.
 Alveoli protetti
 Cavo 1,5 m 3x1 mm²
 Spina 10A 90°
 Corpo in polimero bianco

Normative

CEI 23-50
 CEI 23-122

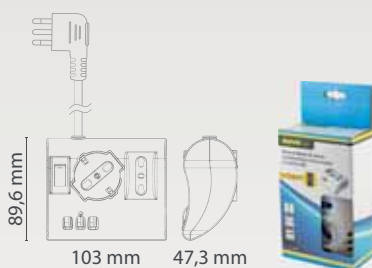

Codice	Spina	Interr.	USB	Uscite	Tensione	Confez.	Imballo/Pz	8028274
CE390	2 Poli+T 16A	on/off/Reset	3 x 3,1A	Schuko Trival. + 2xBip. 10/16A+T	250 V~	Scatola	1/40	...120745

Da tavolo, con interruttore e porta USB.
 Alveoli protetti
 Cavo 2 m H05VV-F 3G1.0 mm²
 Corpo in polimero bianco

Normative

CEI 23-50
 CEI 23-122

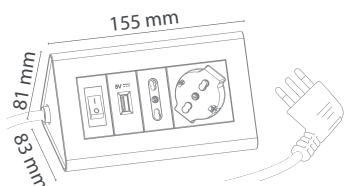

Codice	Spina	Interr.	USB	Uscite	Tensione	Confez.	Imballo/Pz	8028274
CE350	2 Poli+T 16A	on/off	1 x 2,1A	Schuko Trival. + Bipasso 10/16A+T	250 V~	Blister	6/24	...108682



PROLUNGHE



Prolunghe

Cavo 3G1 mm² lineare

Normative

CEI 20-11

CEI 23-50

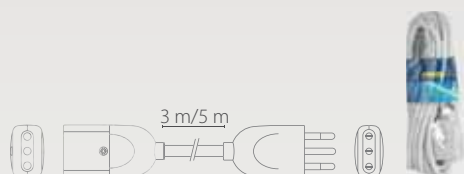

Codice	Spina	Presa	Lungh. cavo	Colore	Tensione	Confezione	Imballo/Pz	8028274
CE32BC	2 Poli + T 10A	2 Poli + T 10A	3m	Bianco	250 V~	Busta	1/30	...013269
CE32NC	2 Poli + T 10A	2 Poli + T 10A	3m	Nero	250 V~	Busta	1/30	...013290
CE33BC	2 Poli + T 10A	2 Poli + T 10A	5m	Bianco	250 V~	Busta	1/30	...013245
CE33NC	2 Poli + T 10A	2 Poli + T 10A	5m	Nero	250 V~	Busta	1/30	...013313

Cavo 3G1 mm² lineare

Normative

CEI 20-11

CEI 23-50

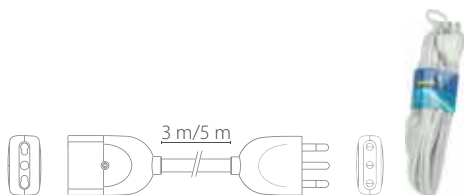

Codice	Spina	Presa	Lungh. cavo	Colore	Tensione	Confezione	Imballo/Pz	8028274
CE54BC	2 Poli + T 16A	2 Poli + T 10/16A	3m	Bianco	250 V~	Busta	1/30	...013207
CE54NC	2 Poli + T 16A	2 Poli + T 10/16A	3m	Nero	250 V~	Busta	1/30	...013337
CE55BC	2 Poli + T 16A	2 Poli + T 10/16A	5m	Bianco	250 V~	Busta	1/30	...013214
CE55NC	2 Poli + T 16A	2 Poli + T 10/16A	5m	Nero	250 V~	Busta	1/30	...013351

Prolunghe

Cavo 3G1 mm² lineare

Normative

CEI 20-11

CEI 23-50



Cod. CE350B

Cod. CE330B

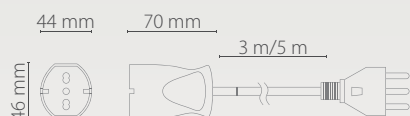

Codice	Spina	Presa	Lungh. cavo	Colore	Tensione	Confezione	Imballo/Pz	8028274
CE330B	2 Poli+T 16A	Schuko+Bivalente 10/16A+T	3m	Bianco	250 V~	Shrink Pack	1/25	...017067
CE350B	2 Poli+T 16A	Schuko+Bivalente 10/16A+T	5m	Bianco	250 V~	Shrink Pack	1/25	...017074

Prolunga con interruttore di protezione

Normative

CEI 20-11

CEI 23-50

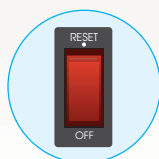

**Protezione
sovraccarico
con Reset**

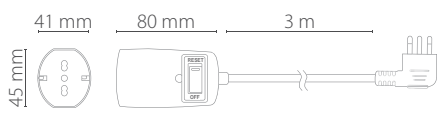

Codice	Spina	Presa	Lungh. cavo	Colore	Confezione	Imballo/Pz	8028274
CE380PKC	2 Poli+T 10A	Schuko+Bivalente 10/16A+T	3m	Bianco	Shrink Pack	1/25	...114225

Prolunga da giardino

Cavo 3x1,5mm² lineare

Normative

CEI 20-11

CEI 23-50

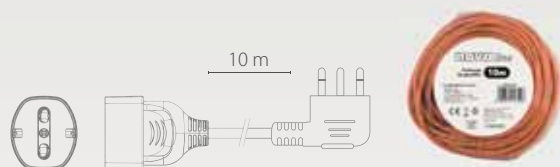

Codice	Spina	Pres	Lungh. cavo	Colore	Tensione	Confezione	Imballo/Pz	8028274
CE3010	2 Poli + T 16A	Schuko	10m	Arancio	250 V~	Termoretraibile	1/6	...117523

Cavo 2x1,5mm² lineare

Normative

CEI 20-11

CEI 23-50

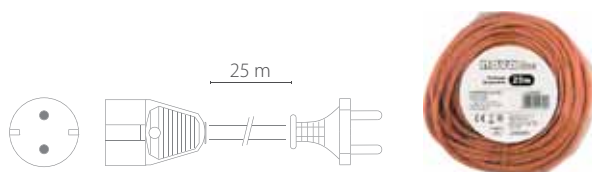

Codice	Spina	Pres	Lungh. cavo	Colore	Tensione	Confezione	Imballo/Pz	8028274
CE2025	Schuko	Schuko	25m	Arancio	250 V~	Termoretraibile	1/6	...117530

Guscio per prolunghe da giardino

Guscio per spine e prese IP44

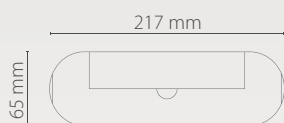

Codice	Grado di protezione	Colore	Confezione	Imballo/Pz	8028274
CE320	IP44	Rosso	Shrink Pack	6/48	...104332



Prolunga avvolgicavo

Disgiuntore termico
Cavo 3G1,5 mm²

Normative

CEI 20-11
CEI 23-50

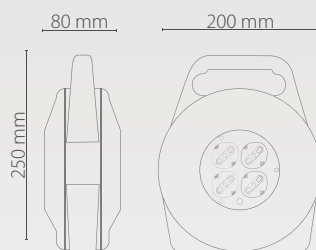

Codice	Spina	Uscite	Tensione	Confezione	Imballo/Pz	8028274
CE120/5	2 Poli + T 16A	4xSchuko 10/16A+T	250 V~	Termoretraibile	1/5	...113396
CE120/10	2 Poli + T 16A	4xSchuko 10/16A+T	250 V~	Termoretraibile	1/5	...013450

Supporto in ferro zincato
Disgiuntore termico
Cavo 20 m 3G1,5 mm²

Professional
application

Normative

CEI 20-11
CEI 23-50

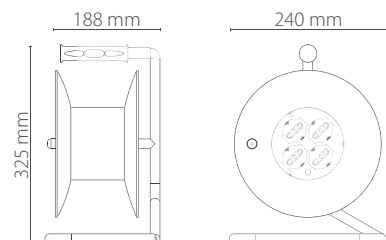

Codice	Spina	Uscite	Tensione	Confezione	Imballo/Pz	8028274
CE76	2 Poli + T 16A	4xSchuko 10/16A+T	250 V~	Termoretraibile	1/2	...013184



CAVI DI ALIMENTAZIONE

Cavi con interruttore

Per abat-jour
Cavo 1,5 m 2G0,75 mm²

Normative

CEI 20-11
CEI 23-50



Cod. CE121B



Cod. CE121N

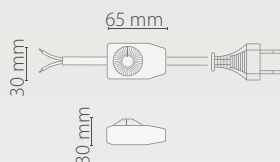

Codice	Spina	Interruttore	Tensione	Colore	Confezione	Imballo/Pz	8028274
CE121B	2 Poli CEE 7/16	Varialuce Rotativo	250 V~, 2,5A	Bianco	Blister	1/10	...013818
CE121N	2 Poli CEE 7/16	Varialuce Rotativo	250 V~, 2,5A	Nero	Blister	1/10	...013825

Per abat-jour
Cavo 1,5 m 2G0,75 mm²

Normative

CEI 20-11
CEI 23-50



Cod. CE97



Cod. CE98

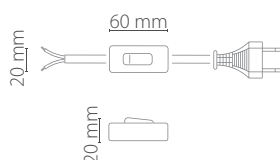

Codice	Spina	Interruttore	Tensione	Colore	Confezione	Imballo/Pz	8028274
CE97	2 Poli CEE 7/16	Bilanciere	250 V~, 2,5A	Bianco	Blister	1/10	...011524
CE98	2 Poli CEE 7/16	Bilanciere	250 V~, 2,5A	Nero	Blister	1/10	...011531

Cavi di alimentazione

Colore nero

Normative

CEI 20-11

CEI 23-50



Cod. CE01

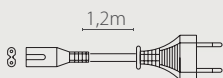

Cod. CE02



Cod. CE107



Codice	Spina	Uscite	Tensione	Cavo	Confezione	Imballo/Pz	8028274
CE01	2 Poli CEE 7/16	C7 Bipolare 2,5A	250 V~	1,2m 2G 0,75mm ²	Blister	1/10	...013016
CE02	2 Poli + T 10A	C13	250 V~	1,5m 3G 0,75mm ²	Blister	1/10	...013030
CE107	2 Poli + T 10A	C5 Tripolare 2,5A	250 V~	1,5m 3G 0,75mm ²	Blister	1/10	...013436





ACCESSORI
PER CABLAGGIO

Interruttori

Rompifilo unipolare
Morsetto passante in policarbonato

Normative

CEI 23-89

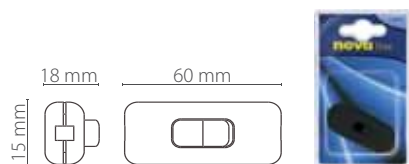

Codice	Tipologia	Tensione	Colore	Confezione	Imballo/Pz	8028274
CE73B	Bilanciere	250 V~, 2A	Bianco	Blister	1/10	...015294
CE73N	Bilanciere	250 V~, 2A	Nero	Blister	1/10	...015300

Nastri isolanti

Domestico

In PVC autoestinguente
Spessore 0,13mm
Lunghezza 10m

Normative
IEC 60454-2



Cod. CE30X2



Cod. CE30B2



Cod. CE30N2

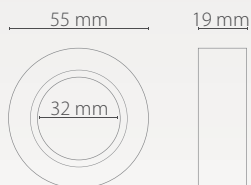

Cod. CE30B10C



Cod. CE30N10C



Code	n° Pz/Conf	Materiale	Colore	Confezione	Imballo/Pz	8028274
CE30B2	2	PVC Autoestinguente	Bianco	Busta	1/10	...112900
CE30B10C	10	PVC Autoestinguente	Bianco	Sfuso x 10	1/50	...112887
CE30N2	2	PVC Autoestinguente	Nero	Busta	1/10	...112917
CE30N10C	10	PVC Autoestinguente	Nero	Sfuso x 10	1/50	...112894
CE30X2	2	PVC Autoestinguente	Bianco+Nero	Busta	1/10	...112924

Connettori Waterproof

Scatola IP65 3P

Conduttore in rame
In poliammide 66
Anelli isolanti in silicone
Colore nero

Normative
CEI 48-70

Professional
application

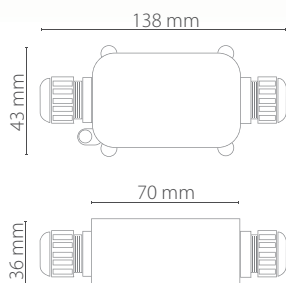

Codice	Tensione	Uscite	Cavo	Confezione	Imballo/Pz	8028274
JB65	Max 450V~, 24A	4-8mm, 4-8mm	max 2,5mm ²	Busta	1/100	...098938

Connettori Waterproof

Lineare IP68 3P

Conduttore in rame
In poliammide 66
Anelli isolanti in silicone
Colore nero
Diametro cavi da 9 a 11mm

Professional
application



Normative
CEI 48-70

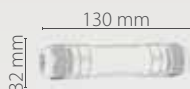

Codice	Tensione	Imballo/Pz	8028274
JB68	Max 250V~, 16A	1/10	...098921

A "T" IP68 3P

Conduttore in rame
In poliammide 66
Anelli isolanti in silicone
Colore nero
Diametro cavi da 9 a 11mm

A croce IP68 3P

Conduttore in rame
In poliammide 66
Anelli isolanti in silicone
Colore nero
Diametro cavi da 9 a 11mm

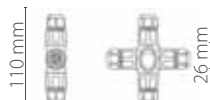

Codice	Tensione	Imballo/Pz	8028274
JB68T	Max 250V~, 16A	1/10	...105926

Codice	Tensione	Imballo/Pz	8028274
JB68X	Max 250V~, 16A	1/10	...105933

Unipolari
Stecche separabili
In policarbonato e ottone

Normative

CEI 23-21

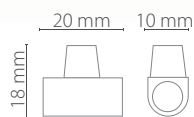

Cod. CE41/1

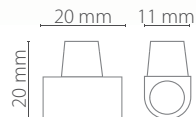

Cod. CE41/2

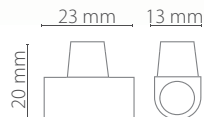

Cod. CE41/3



Codice	n° Pz/Conf	Dimensione	Colore	Confezione	Imballo/Pz	8028274
CE41/1	10	2,5 mm	Trasparente	Blister	1/10	...015096
CE41/1S	100	2,5 mm	Trasparente	Sfuso	1	-
CE41/2	10	4 mm	Trasparente	Blister	1/10	...015102
CE41/2S	100	4 mm	Trasparente	Sfuso	1	-
CE41/3	10	6 mm	Trasparente	Blister	1/10	...015119
CE41/3S	100	6 mm	Trasparente	Sfuso	1	-

Graffette fissacavo e Fascette

Forma tonda in polietilene
con chiodi in acciaio zincato incorporati

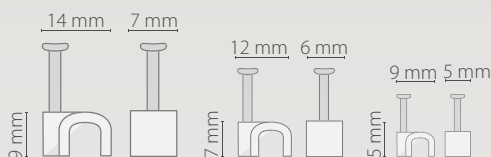

Cod. CE40/3
Cod. CE40/3S



Cod. CE40/2
Cod. CE40/2S



Cod. CE40/1
Cod. CE40/1S

Codice	n° Pz/Conf	Dimensione	Colore	Confezione	Imballo/Pz	8028274
CE40/1	50	ø 3/4 mm	Bianco	Blistere	1/10	...015065
CE40/1S	100	ø 3/4 mm	Bianco	Sfuso	1	-
CE40/2	50	ø 5/6 mm	Bianco	Blistere	1/10	...015072
CE40/2S	100	ø 5/6 mm	Bianco	Sfuso	1	-
CE40/3	50	ø 6/7 mm	Bianco	Blistere	1/10	...015089
CE40/3S	100	ø 6/7 mm	Bianco	Sfuso	1	-

Autobloccanti in nylon 66

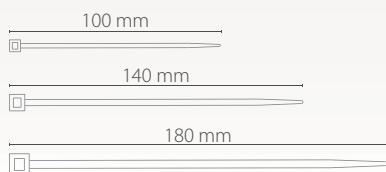

Cod. CE42/3
Cod. CE42/3S



Cod. CE42/2
Cod. CE42/2S



Cod. CE42/1
Cod. CE42/1S



Cod. CE53/3
Cod. CE53/3S



Cod. CE53/2
Cod. CE53/2S



Cod. CE53/1
Cod. CE53/1S

Codice	n° Pz/Conf	Dimensione	Colore	Confezione	Imballo/Pz	8028274
CE42/1	25	100 x 2,5 mm	Nero	Busta	1/10	...015126
CE42/1S	100	100 x 2,5 mm	Nero	Sfuso	1	-
CE42/2	25	140 x 3,5 mm	Nero	Busta	1/10	...015133
CE42/2S	100	140 x 3,5 mm	Nero	Sfuso	1	-
CE42/3	25	180 x 4,5 mm	Nero	Busta	1/10	...015140
CE42/3S	100	180 x 4,5 mm	Nero	Sfuso	1	-
CE53/1	25	100 x 2,5 mm	Bianco	Busta	1/10	...015188
CE53/1S	100	100 x 2,5 mm	Bianco	Sfuso	1	-
CE53/2	25	140 x 3,5 mm	Bianco	Busta	1/10	...015195
CE53/2S	100	140 x 3,5 mm	Bianco	Sfuso	1	-
CE53/3	25	180 x 4,5 mm	Bianco	Busta	1/10	...015201
CE53/3S	100	180 x 4,5 mm	Bianco	Sfuso	1	-

Morsetti a più vie 1-4 mmq

Normative

CEI 23-21

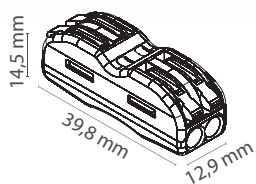
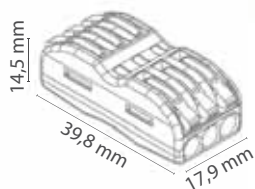

Codice	n° Pz/Conf	Tipo	Colore	Confezione	Imballo/Pz	8028274
CLT2/2C	10	2 x 2 vie	Trasparente	Busta	1/10	...121704
CLT2/2S	100	2 x 2 vie	Trasparente	Sfuso	1	--
CLT2/3C	10	2 x 3 vie	Trasparente	Busta	1/10	...114393
CLT2/3S	100	2 x 3 vie	Trasparente	Sfuso	1	--

Morsetti

Morsetti a più vie 1-4 mmq

Normative
CEI 23-21



Cod. CLT1/2C
Cod. CLT1/2S



Cod. CLT1/3C
Cod. CLT1/3S



Cod. CLT1/5C
Cod. CLT1/5S

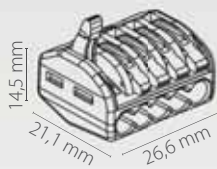
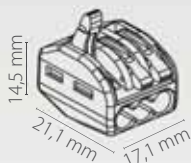
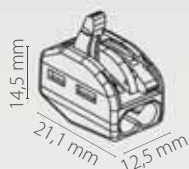

Codice	n° Pz/Conf	Tipo	Colore	Confezione	Imballo/Pz	8028274
CLT1/2C	10	2 vie	Grigio	Busta	1/10	...114362
CLT1/2S	100	2 vie	Grigio	Sfuso	1	--
CLT1/3C	10	3 vie	Grigio	Busta	1/10	...114379
CLT1/3S	100	3 vie	Grigio	Sfuso	1	--
CLT1/5C	10	5 vie	Grigio	Busta	1/10	...114386
CLT1/5S	100	5 vie	Grigio	Sfuso	1	--

Kit di morsetti a piu vie

Morsetto a 2 vie 1-4 mmq - 30 pz

Morsetto a 3 vie 1-4 mmq - 20 pz

Morsetto a 5 vie 1-4 mmq - 10 pz

Normative
CEI 23-21



30x



20x



10x



Codice	Contenuto	Confezione	Imballo/Pz	8028274
CLT1KIT	30 x 2 vie - 20 x 3 vie - 10 x 5 vie	Scatola multiscparto	1/40	...114409

Morsetti a più vie 1-4 mmq

Normative

CEI 23-21



Cod. CLT3RS



Cod. CLT3GS



Cod. CLT3BS



Cod. CLT4RS



Cod. CLT4GS



Cod. CLT4BS

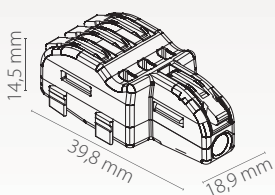
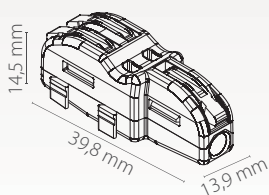

Codice	n° Pz/Conf	Tipo	Colore	Confezione	Imballo/Pz	8028274
CLT3R	10	3 vie	Rosso	Busta	1/10	...121094
CLT3RS	100	3 vie	Rosso	Sfuso	1	--
CLT3G	10	3 vie	Giallo	Busta	1/10	...121100
CLT3GS	100	3 vie	Giallo	Sfuso	1	--
CLT3B	10	3 vie	Blu	Busta	1/10	...121117
CLT3BS	100	3 vie	Blu	Sfuso	1	--
CLT4R	10	4 vie	Rosso	Busta	1/10	...121124
CLT4RS	100	4 vie	Rosso	Sfuso	1	--
CLT4G	10	4 vie	Giallo	Busta	1/10	...121131
CLT4GS	100	4 vie	Giallo	Sfuso	1	--
CLT4B	10	4 vie	Blu	Busta	1/10	...121148
CLT4BS	100	4 vie	Blu	Sfuso	1	--

Morsetti a più vie 1-4 mmq

Normative
CEI 23-21



Cod. CLT5RS



Cod. CLT5GS



Cod. CLT5BS



Cod. CLT6RS



Cod. CLT6GS



Cod. CLT6BS

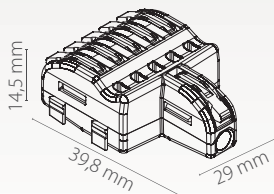
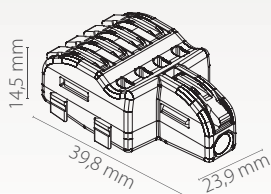

Codice	n° Pz/Conf	Tipo	Colore	Confezione	Imballo/Pz	8028274
CLT5R	10	5 vie	Rosso	Busta	1/10	...121155
CLT5RS	100	5 vie	Rosso	Sfuso	1	--
CLT5G	10	5 vie	Giallo	Busta	1/10	...121162
CLT5GS	100	5 vie	Giallo	Sfuso	1	--
CLT5B	10	5 vie	Blu	Busta	1/10	...121179
CLT5BS	100	5 vie	Blu	Sfuso	1	--
CLT6R	10	6 vie	Rosso	Busta	1/10	...121186
CLT6RS	50	6 vie	Rosso	Sfuso	1	--
CLT6G	10	6 vie	Giallo	Busta	1/10	...121193
CLT6GS	50	6 vie	Giallo	Sfuso	1	--
CLT6B	10	6 vie	Blu	Busta	1/10	...121209
CLT6BS	50	6 vie	Blu	Sfuso	1	--

Morsetti

Supporto quadro sfuso

Normative

CEI 23-21

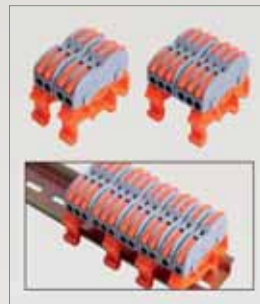
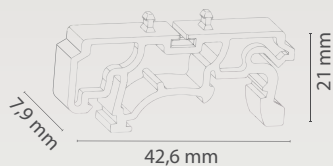

Codice	n° Pz/Conf	Confezione	Imballo/Pz	8028274
SQ42	10	Busta	1/10	...121216
SQ42S	100	Sfuso	1	--

Supporto con viti sfuso

Normative

CEI 23-21

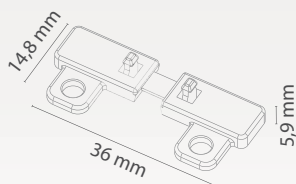

Codice	n° Pz/Conf	Confezione	Imballo/Pz	8028274
SV43	10	Busta	1/10	...121223
SV43S	200	Sfuso	1	--

Supporto con viti sfuso

Normative

CEI 23-21

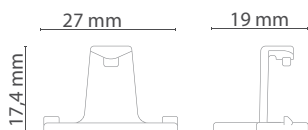

Codice	n° Pz/Conf	Confezione	Imballo/Pz	8028274
SVP43	10	Busta	1	...123586

PORTALAMPADE E ACCESSORI



Portalampade

Corpo in termoplastico bianco,
Morsetti e contatti in ottone

Normative

CEI EN 60838



Cod. CE104



Cod. CE81

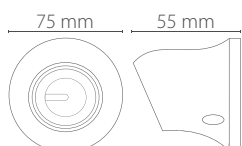
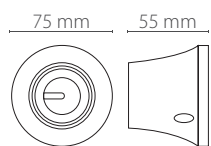

Codice	Attacco	Tensione	Colore	Portata Mass.	Confezione	Imballo/Pz	8028274
CE104	E27 base dritta	250 V~, 4A	Bianco	40W	Busta	10/100	...011753
CE81	E27 base angolata	250 V~, 4A	Bianco	40W	Busta	10/100	...015393

Portalampade

Corpo in termoplastica liscia
Morsetti e contatti in ottone
Cappuccio con entrata filettata sagomata

Normative
CEI EN 60838



Cod. CE23B
Cod. CE23E



Cod. CE24
Cod. CE24C

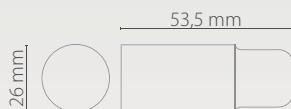

Confezionato
in box espositivo

Codice	Attacco	Tensione	Colore	Confezione	Imballo/Pz	8028274
CE23B	E27	250 V~, 4A	Bianco	C-Box	10/100	...125085
CE23E	E27	250 V~, 4A	Bianco	Scatola	30/240	...125535
CE24B	E14	250 V~, 2A	Bianco	C-Box	10/100	...125108
CE24C	E14	250 V~, 2A	Bianco	Busta	1/36	...015614

Portalampada con ghiera
Cappuccio con entrata filettata sagomata
Morsetti e contatti in ottone
Corpo in camicia parzialmente
filettata con battuta fermaparalume

Normative
CEI EN 60838



Cod. CE102



Cod. CE103
Cod. CE103E

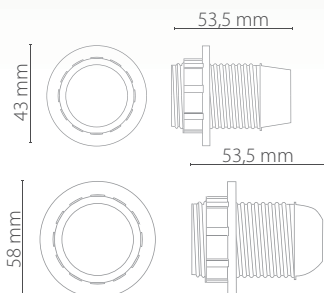

Confezionato
in box espositivo

Codice	Attacco	Tensione	Colore	Confezione	Imballo/Pz	8028274
CE102	E14 con ghiera	250 V~, 2A	Bianco	Blister	1/10	...011739
CE103	E27 con ghiera	250 V~, 4A	Bianco	Blister	1/10	...011746
CE103E	E27 con ghiera	250 V~, 4A	Bianco	Sfuso EAN	15/120	...124170

Adattatori Portalampada

Attacco in ottone nichelato e contatti in rame
 Corpo in PBT ritardante di fiamma
 Colore bianco

Normative

CEI EN 60838

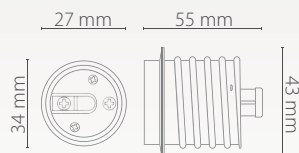
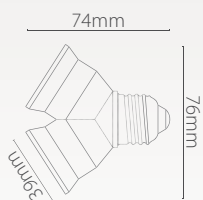
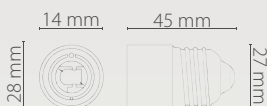

Codice	Attacco	Tensione	Colore	Confezione	Imballo/Pz	8028274
CL2714	da E27 a E14	240 V~, 2A	Bianco	Busta	10/200	...016512
CL2710	da E27 a GU10	240 V~, 2A	Bianco	Busta	10/200	...016536
CL2X27	da E27 a 2xE27	240 V~, 2A	Bianco	Busta	10/200	...016574
CL4027	da E40 a E27	240 V~, 2A	Bianco	Busta	1/10	...097481

Adattatori Portalampada

Attacco in ottone nichelato e contatti in rame
 Corpo in PBT ritardante di fiamma
 Colore bianco

Normative
 CEI EN 60838

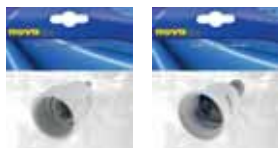

Codice	Attacco	Tensione	Colore	Confezione	Imballo/Pz	8028274
CL1027	da GU10 a E27	240 V~, 2A	Bianco	Busta	10/200	...016543
CL1014	da GU10 a E14	240 V~, 2A	Bianco	Busta	10/200	...016567
CL1427	da E14 a E27	240 V~, 2A	Bianco	Busta	10/200	...016529
CL1410	da E14 a GU10	240 V~, 2A	Bianco	Busta	10/200	...016550



ACCESSORI ANTENNE



Spine e Prese antenna

Dritte

Corpo termoplastico bianco, fermacavo morsa

Normative

CEI 100 -7



Codice	n° Pz/Conf.	Attacco	Dimensione	Colore	Confezione	Imballo/Pz	8028274
CE21	1	Spina 75 Ohm	ø 9,5 mm	Bianco	Blister	10/100	...011128
CE21S	100	Spina 75 Ohm	ø 9,5 mm	Bianco	Sfuso	1	-
CE22	1	Presca 75 Ohm	ø 9,5 mm	Bianco	Blister	10/100	...011135
CE22S	100	Presca 75 Ohm	ø 9,5 mm	Bianco	Sfuso	1	-
CE26	2	Spina+Presca 75 Ohm	ø 9,5 mm	Bianco	Blister	10/100	...011159

Angolari

Corpo termoplastico bianco, fermacavo morsa

Normative

CEI 100 -7

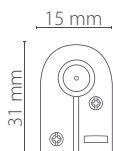
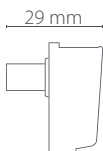
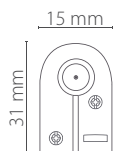

Codice	n° Pz/Conf.	Attacco	Dimensione	Colore	Confezione	Imballo/Pz	8028274
CE25	1	Spina angolata 75 Ohm	ø 9,5 mm	Bianco	Blister	1/10	...011142
CE25S	100	Spina angolata 75 Ohm	ø 9,5 mm	Bianco	Sfuso	1	-
CE94	1	Presca angolata 75 Ohm	ø 9,5 mm	Bianco	Blister	1/10	...011548
CE94S	100	Presca angolata 75 Ohm	ø 9,5 mm	Bianco	Sfuso	1	-

Spine e Prese antenna

Dritte

Corpo in metallo

Normative

CEI 100 -7



Cod. CE95
Cod. CE95S



Cod. CE96
Cod. CE96S



Codice	n° Pz/Conf.	Attacco	Dimensione	Colore	Confezione	Imballo/Pz	8028274
CE95	1	Doppia Spina 75 Ohm	ø 9,5 mm	Metallo	Blister	1/10	...011555
CE95S	100	Doppia Spina 75 Ohm	ø 9,5 mm	Metallo	Sfuso	1	-
CE96	1	Doppia Presa 75 Ohm	ø 9,5 mm	Metallo	Blister	1/10	...011562
CE96S	100	Doppia Presa 75 Ohm	ø 9,5 mm	Metallo	Sfuso	1	-

Angolari

Corpo in metallo
Impugnatura in termoplastico

Normative

CEI 100 -7



Cod. CV04



Cod. CV05

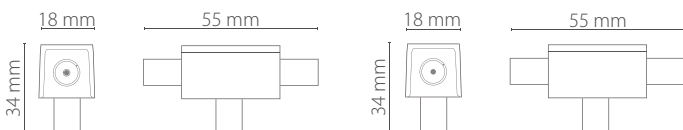

Codice	n° Pz/Conf.	Attacco	Dimensione	Colore	Confezione	Imballo/Pz	8028274
CV04	1	Spina + 2 Prese 75 Ohm	ø 9,5 mm	Metallo	Blister	1/10	...022063
CV05	1	Preso + 2 Spine 75 Ohm	ø 9,5 mm	Metallo	Blister	1/10	...022469

Cavi antenna Coassiali

Kit cavo con raccordo
Conduttore in rame e calza schermante

Normative

CEI 100 -7



Cod. CV46



Cod. CV47

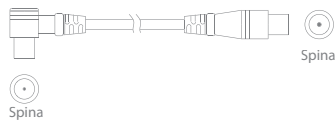
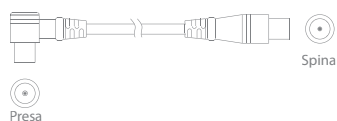

Codice	Attacchi	Dimensione	Lung. Cavo	Colore	Confezione	Imballo/Pz	8028274
CV46	Spina + Presa 90° 75 Ohm	ø 9,5 mm	1,5 m	Nero	Blister	1/10	...022759
CV47	Spina + Spina 90° 75 Ohm	ø 9,5 mm	1,5 m	Nero	Blister	1/10	...022766

Cavi antenna Coassiali

Conduttore in rame e calza schermante

Normative

CEI 100 -7



Cod. CV02-1
Cod. CV02-3
Cod. CV02-5

Cod. CV02-1S
Cod. CV02-3S
Cod. CV02-5S



Cod. CV03-1
Cod. CV03-3
Cod. CV03-5

Cod. CV03-1S
Cod. CV03-3S
Cod. CV03-5S



Codice	Attacchi	Raccordo	Dimensione	Lung. Cavo	Colore	Confezione	Imballo/Pz	8028274
CV02/1	2 Spine 75 Ohm	Doppia presa	ø 9,5 mm	2 m	Bianco	Blister	1/10	...022025
CV02/1C	2 Spine 75 Ohm	Doppia presa	ø 9,5 mm	2 m	Bianco	Busta	1/20	...022803
CV02/1S	2 Spine 75 Ohm	Doppia presa	ø 9,5 mm	2 m	Bianco	Sfuso	1	-
CV02/3	2 Spine 75 Ohm	Doppia presa	ø 9,5 mm	3 m	Bianco	Blister	1/10	...022032
CV02/3C	2 Spine 75 Ohm	Doppia presa	ø 9,5 mm	3 m	Bianco	Busta	1/20	...022995
CV02/3S	2 Spine 75 Ohm	Doppia presa	ø 9,5 mm	3 m	Bianco	Sfuso	1	-
CV02/5	2 Spine 75 Ohm	Doppia presa	ø 9,5 mm	5 m	Bianco	Blister	1/10	...022322
CV02/5C	2 Spine 75 Ohm	Doppia presa	ø 9,5 mm	5 m	Bianco	Busta	1/20	...022964
CV02/5S	2 Spine 75 Ohm	Doppia presa	ø 9,5 mm	5 m	Bianco	Sfuso	1	-
CV03/1	Spina + Presa 75 Ohm	Doppia spina	ø 9,5 mm	2 m	Nero	Blister	1/10	...022056
CV03/1C	Spina + Presa 75 Ohm	Doppia spina	ø 9,5 mm	2 m	Nero	Busta	1/20	...022810
CV03/1S	Spina + Presa 75 Ohm	Doppia spina	ø 9,5 mm	2 m	Nero	Sfuso	1	-
CV03/3	Spina + Presa 75 Ohm	Doppia spina	ø 9,5 mm	3 m	Nero	Blister	1/10	...022414
CV03/3C	Spina + Presa 75 Ohm	Doppia spina	ø 9,5 mm	3 m	Nero	Busta	1/20	...022971
CV03/3S	Spina + Presa 75 Ohm	Doppia spina	ø 9,5 mm	3 m	Nero	Sfuso	1	-
CV03/5	Spina + Presa 75 Ohm	Doppia spina	ø 9,5 mm	5 m	Nero	Blister	1/10	...022452
CV03/5C	Spina + Presa 75 Ohm	Doppia spina	ø 9,5 mm	5 m	Nero	Busta	1/20	...022988
CV03/5S	Spina + Presa 75 Ohm	Doppia spina	ø 9,5 mm	5 m	Nero	Sfuso	1	-

Adattatori Satellitari

Corpo in ottone nichelato
Impermeabile con anello in gomma

Normative

CEI 100 -7

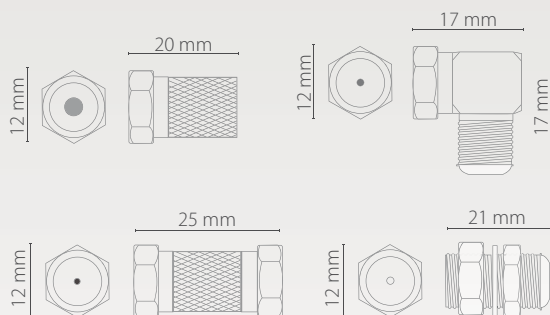

Cod. CS01/5
Cod. CS01/6
Cod. CS01/7

Cod. CS02
Cod. CS02S



Cod. CS06
Cod. CS06S

Cod. CS04
Cod. CS04S



Codice	n° Pz/Conf.	Attacco	Dimensione	Colore	Confezione	Imballo/Pz	8028274
CS01/5	2	Spina volante "F" ad avvitamento	ø 5 mm	Metallo	Blister	1/10	...022834
CS01/5S	100	Spina volante "F" ad avvitamento	ø 5 mm	Metallo	Sfuso	1	-
CS01/6	2	Spina volante "F" ad avvitamento	ø 6,2 mm	Metallo	Blister	1/10	...022841
CS01/6S	100	Spina volante "F" ad avvitamento	ø 6,2 mm	Metallo	Sfuso	1	-
CS01/7	2	Spina volante "F" ad avvitamento	ø 6,8 mm	Metallo	Blister	1/10	...022858
CS01/7S	100	Spina volante "F" ad avvitamento	ø 6,8 mm	Metallo	Sfuso	1	-
CS02	1	Spina "F" + Presa "F" 90°	-	Metallo	Blister	1/10	...022865
CS02S	100	Spina "F" + Presa "F" 90°	-	Metallo	Sfuso	1	-
CS04	1	Raccordo volante Presa "F" + Presa "F"	-	Metallo	Blister	1/10	...022889
CS04S	100	Raccordo volante Presa "F" + Presa "F"	-	Metallo	Sfuso	1	-
CS06	1	Raccordo volante Spina "F" + Spina "F"	-	Metallo	Blister	1/10	...022872
CS06S	100	Raccordo volante Spina "F" + Spina "F"	-	Metallo	Sfuso	1	-

Cavi antenna Sat

Conduttore e calza schermata

Normative

CEI 100 -7



Cod. CS07/2
Cod. CS07/5



Cod. CS08/2
Cod. CS08/5



Cod. CS05/1
Cod. CS05/3



Codice	Attacchi	Dimensione	Lung. Cavo	Colore	Confezione	Imballo/Pz	8028274
CS07/2	Spina 75 Ohm + Spina "F"	ø 9,5 mm	2 m	Nero	Blister	1/10	...015751
CS07/5	Spina 75 Ohm + Spina "F"	ø 9,5 mm	5 m	Nero	Blister	1/10	...015775
CS08/2	Presa 75 Ohm + Spina "F"	ø 9,5 mm	2 m	Nero	Blister	1/10	...015799
CS08/5	Presa 75 Ohm + Spina "F"	ø 9,5 mm	5 m	Nero	Blister	1/10	...015812
CS05/1	Spina Sat "F" + Spina "F"	ø 9,5 mm	1,5 m	Nero	Blister	1/10	...022902
CS05/3	Spina Sat "F" + Spina "F"	ø 9,5 mm	3 m	Nero	Blister	1/10	...022919



TIMER E SENSORI



Timer

Settimanale

Display LCD
Batteria incorporata
Programmazione giornaliera e settimanale
Intervallo minimo 1 minuto
Multifunzionale

Normative

CEI EN 60335

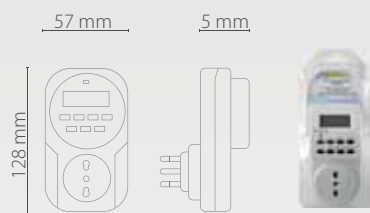

Codice	Spina	Presa	Portata mass.	Uso	Confezione	Imballo/Pz	8028274
TD078	2 Poli + T 16A	2 Poli + T 10/16A	3600 W	Interno	Blister	12/48	...051544

Giornaliero

Programmabile
Con 96 intervalli (min. 15 minuti)

Normative

CEI EN 60335

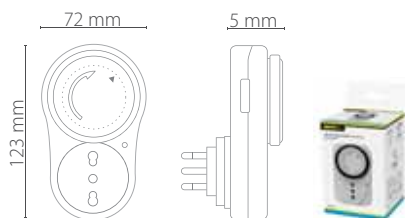

Codice	Spina	Presa	Portata mass.	Uso	Confezione	Imballo/Pz	8028274
T100	2 Poli + T 16A	2 Poli + T 10/16A	3500 W	Interno	Scatola	18	...051384

Sensori da parete

Sensore di movimento a raggi infrarossi IP65
 Funzione crepuscolare
 Luce ambiente regolabile 3-2000 lux
 Temporizzazione regolabile 10 sec.-15 min.

Normative

CEI EN 60335

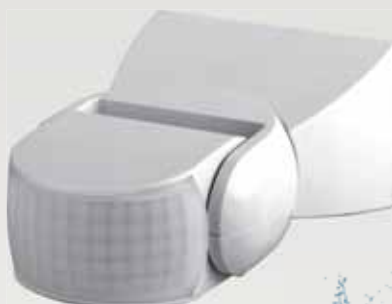
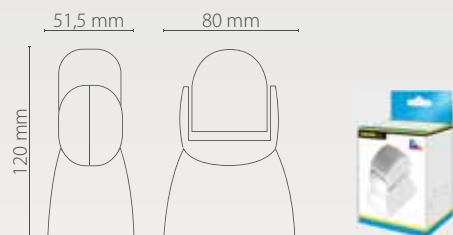

Codice	Tensione	Port. mass.	Ang. Rilev.	Dist. Rilev.	Grado Prot.	Confezione	Imballo/Pz	8028274
F4065	220-240V	1200 W	180°	12 m	IP65	Scatola	1/50	...100006

Sensore di movimento a raggi infrarossi
 Funzione crepuscolare
 Luce ambiente regolabile 3-2000 lux
 Temporizzazione regolabile 10 sec.-7 min.

Normative

CEI EN 60335

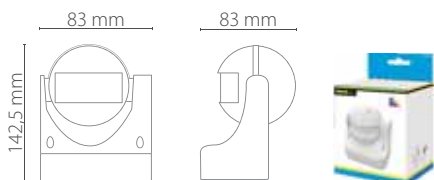

Codice	Tensione	Port. mass.	Ang. Rilev.	Dist. Rilev.	Grado Prot.	Confezione	Imballo/Pz	8028274
F4000	220-240V	1200 W	180°	12 m	IP44	Scatola	10/40	...051711

Sensori incasso/soffitto

Sensore di movimento a raggi infrarossi
 Funzione crepuscolare
 Luce ambiente regolabile 10-2000 lux
 Temporizzazione regolabile 10 sec.- 10 min.

Normative
 CEI EN 60335

Da incasso



Cod. F4020R

Da soffitto

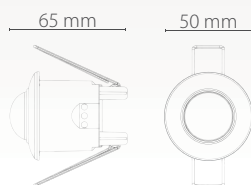
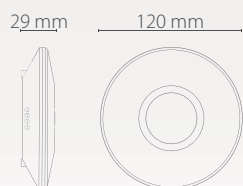

Cod. F4020W



Codice	Tensione	Port. mass.	Ang. Rilev.	Dist. Rilev.	Grado Prot.	Confezione	Imballo/Pz	8028274
F4020R	110-240V	500 W	360°	6 m	IP20	Scatola	1/100	...099843
F4020W	110-240V	2000 W	360°	2-6 m	IP20	Scatola	1/50	...099850

Sensore da installazione

Sensore di movimento a raggi infrarossi
Funzione crepuscolare
Luce ambiente regolabile 10-2000 lux
Temporizzazione regolabile 10 sec.- 7 min.

Normative
CEI EN 60335

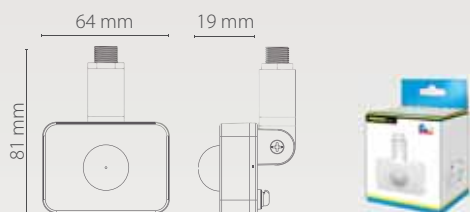

Codice	Tensione	Port. mass.	Ang. Rilev.	Dist. Rilev.	Grado Prot.	Confezione	Imballo/Pz	8028274
F4054	110-240V	1000 W	120°	2-10 m	IP54	Scatola	1/100	...099836

Sensore crepuscolare

Domestico

Sensore crepuscolare
Accensione regolabile <10 - 100 lux
Spegnimento regolabile > 40 - 250 lux

Normative
CEI EN 60335

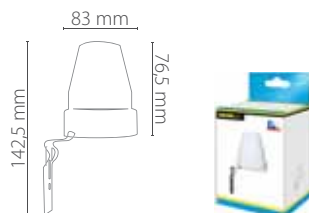

Codice	Tensione	Portata massima	Grado Protezione	Confezione	Imballo/Pz	8028274
SCR100	220-240V	10A	IP44	Scatola	1/100	...098914



PLACCHE E FRUTTI SERIE EGO



Serie EGO LK40

Placche 4 posizioni e supporto

Per scatole ad incasso rettangolari
Corpo in tecnopolimero

Normative

CEI 23-48



Cod. LK40001C



Cod. LK40704BC

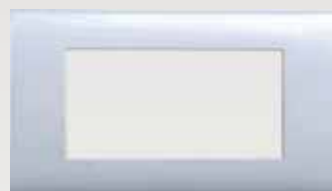

Cod. LK40704GC

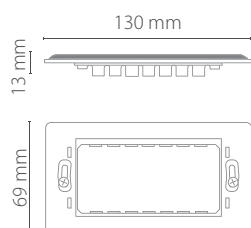
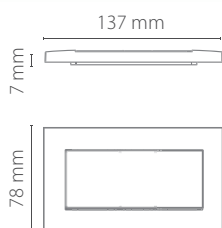

Codice	N° Moduli	Colore	Confezione	Imballo/Pz	8028274
LK40704BC	4	Bianco	Busta	10/250	...028522
LK40704GC	4	Argento	Busta	10/250	...028539
LK40001C	4	Nero	Busta	10/250	...028577

Serie EGO LK40

Placche 3 posizioni e supporto

Per scatole ad incasso rettangolari
Corpo in tecnopolimero

Normative
CEI 23-48



Cod. LK40000C



Cod. LK40703BC



Cod. LK40703GC



Cod. LK40703CC



Cod. LK40703B (+supporto)



Cod. LK40703G (+supporto)



Cod. LK40703C (+supporto)

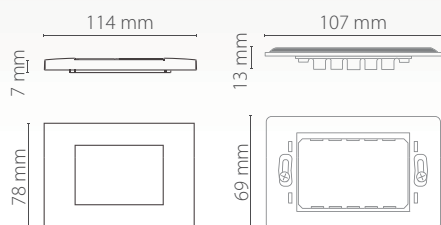

Codice	N° Moduli	Colore	Confezione	Imballo/Pz	8028274
LK40703B	3 + supporto incluso	Bianco	Blister	1/10	...029314
LK40703BC	3	Bianco	Busta	10/100	...029321
LK40703G	3 + supporto incluso	Argento	Blister	1/10	...028485
LK40703GC	3	Argento	Busta	10/100	...029086
LK40703C	3 + supporto incluso	Crema	Blister	1/10	...028492
LK40703CC	3	Crema	Busta	10/100	...029093
LK40000C	3	Nero	Busta	10/250	...029277

Serie EGO LK40

Interruttori, deviatori e invertitori

Comandi con tasto
a bilanciere per scatole
a incasso rettangolari
in tecnopolimero

Normative

CEI 23-122



Cod. LK40578
Cod. LK40578C



Cod. LK40571
Cod. LK40571C



Cod. LK40571L
Cod. LK40571LC



Cod. LK40572
Cod. LK40572C



Cod. LK40573
Cod. LK40573C



Cod. LK40573L
Cod. LK40573LC

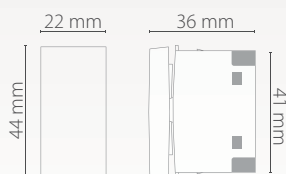

Codice	Tipologia	Tensione	Spia Lum.	Colore	Confezione	Imballo/Pz	8028274
LK40578	Invertitore	16A, 250 V~	No	Bianco	Blister	1/10	...106138
LK40578C	Invertitore	16A, 250 V~	No	Bianco	Scatola	10/500	...105094
LK40571	Interruttore Unipolare	16A, 250 V~	No	Bianco	Blister	1/10	...027013
LK40571C	Interruttore Unipolare	16A, 250 V~	No	Bianco	Scatola	10/500	...029123
LK40571L	Interruttore Unipolare	16A, 250 V~	Sì	Bianco	Blister	1/10	...027044
LK40571LC	Interruttore Unipolare	16A, 250 V~	Sì	Bianco	Scatola	10/500	...029154
LK40572	Interruttore Bipolare	16A, 250 V~	No	Bianco	Blister	1/10	...027020
LK40572C	Interruttore Bipolare	16A, 250 V~	No	Bianco	Scatola	10/500	...029130
LK40573	Deviatore	16A, 250 V~	No	Bianco	Blister	1/10	...027037
LK40573C	Deviatore	16A, 250 V~	No	Bianco	Scatola	10/500	...029147
LK40573L	Deviatore	16A, 250 V~	Sì	Bianco	Blister	1/10	...027051
LK40573LC	Deviatore	16A, 250 V~	Sì	Bianco	Scatola	10/500	...029161

Serie EGO LK40



Pulsanti e Dimmer

Per scatole ad incasso rettangolari
in tecnopolimero

Normative

CEI 23-122



Cod. LK40513L 
Cod. LK40513LC 





Cod. LK40513B 

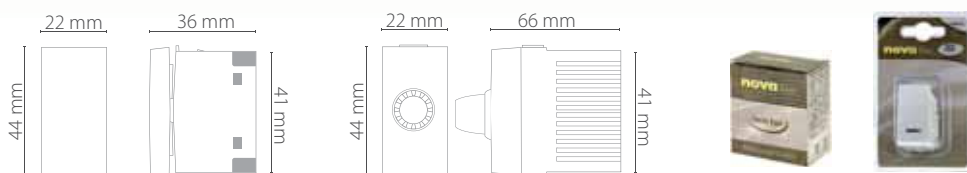

Cod. LK40803
Cod. LK40803C



Codice	Tipologia	Tensione	Spia Lum.	Colore	Confezione	Imballo/Pz	8028274
LK40513L 	Pulsante	10A, 250 V~	Si	Bianco	Blister	1/10	...027075
LK40513LC 	Pulsante	10A, 250 V~	Si	Bianco	Scatola	1/10	...029178
LK40513B 	Pulsante Campanello	10A, 250 V~	Si	Bianco	Blister	1/10	...029543
LK40803	Dimmer 100-900W	240 V~	Si	Bianco	Blister	1/10	...027167
LK40803C	Dimmer 100-900W	240 V~	Si	Bianco	Scatola	1/10	...029185

Serie EGO LK40

Prese

Per scatole ad incasso rettangolari
in tecnopolimero

Normative

CEI 23-122

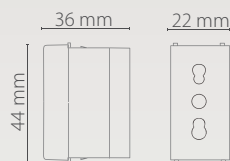

Cod. LK40203
Cod. LK40203C

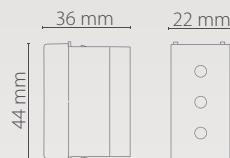

Cod. LK40201
Cod. LK40201C

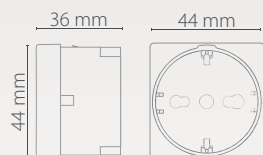

Cod. LK40207
Cod. LK40207C

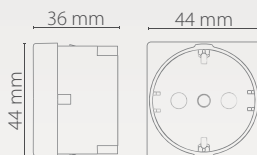

Cod. LK40205
Cod. LK40205C



Codice	Tipologia	Tensione	Colore	Confezione	Imballo/Pz	8028274
LK40203	2 Poli + T10/16A	250 V~	Bianco	Blister	1/10	...027099
LK40203C	2 Poli + T10/16A	250 V~	Bianco	Scatola	10/500	...029215
LK40201	2 Poli + T10A	250 V~	Bianco	Blister	1/10	...027082
LK40201C	2 Poli + T10A	250 V~	Bianco	Scatola	10/500	...029208
LK40207	Schuko 2P 10/16A+T	250 V~	Bianco	Blister	1/10	...106145
LK40207C	Schuko 2P 10/16A+T	250 V~	Bianco	Scatola	10/500	...105087
LK40205	Schuko + T	250 V~	Bianco	Blister	1/10	...027112
LK40205C	Schuko + T	250 V~	Bianco	Scatola	10/500	...029222

Serie EGO LK40

Prese Tel / LAN / Sat / TV

Per scatole ad incasso rettangolari
in tecnopolimero

Normative

CEI 23-122

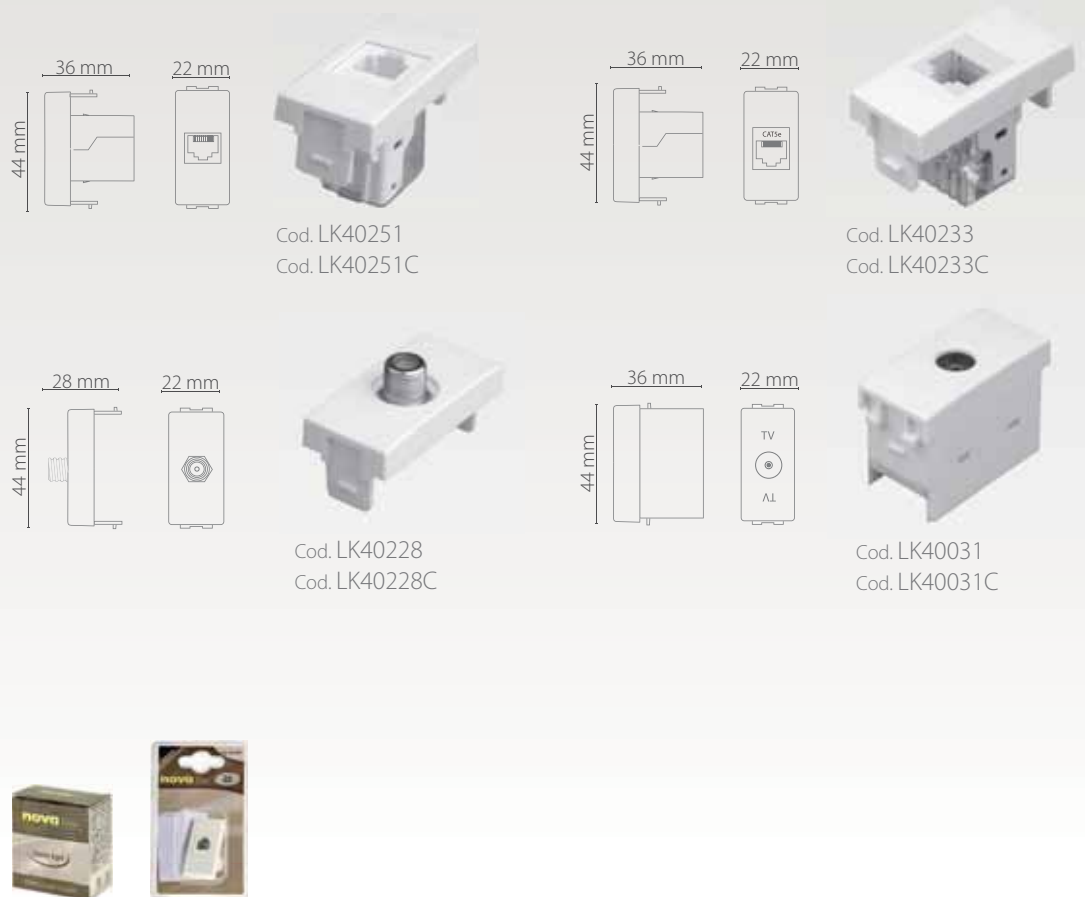

Cod. LK40251
Cod. LK40251C

Cod. LK40233
Cod. LK40233C

Cod. LK40228
Cod. LK40228C

Cod. LK40031
Cod. LK40031C

Codice	Tipo Presa	Colore	Confezione	Imballo/Pz	8028274
LK40251	Telefonica RJ11	Bianco	Blister	1/10	...027136
LK40251C	Telefonica RJ11	Bianco	Scatola	10/500	...029239
LK40233	LAN Plug RJ45 cat. 5E	Bianco	Blister	1/10	...027129
LK40233C	LAN Plug RJ45 cat. 5E	Bianco	Scatola	10/500	...029246
LK40228	SAT "F"	Bianco	Blister	1/10	...027143
LK40228C	SAT "F"	Bianco	Scatola	10/500	...029253
LK40031	TV	Bianco	Blister	1/10	...027150
LK40031C	TV	Bianco	Scatola	10/500	...029260

Serie EGO LK40

Presse USB, Tappi

Porta USB 5 V, 2100 mA

Per scatole ad incasso rettangolari in tecnopolimero.



Normative

CEI 23-48





Cod. LK40044
Cod. LK40044C

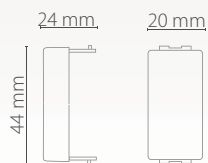

Cod. LK40056 
Cod. LK40056C 



Codice	Tipo Presa	Tensione	Colore	Confezione	Imballo/Pz	8028274
LK40044	USB DC 5V 2,1A	110-240V	Bianco	Blister	1/10	...112962
LK40044C	USB DC 5V 2,1A	110-240V	Bianco	Scatola	10/500	...108699
LK40056 	-	-	Bianco	Blister (2 Pz)	1/10	...027174
LK40056C 	-	-	Bianco	Scatola	10/500	...029192

Serie EGO LK40

Scatole da parete con coperchio

Per installazioni da incasso in scatole rettangolari
completo di viti di fissaggio
in policarbonato

Normative

CEI 23-48

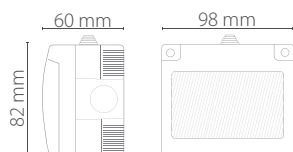

Codice	N° Moduli	Grado Protezione	Colore	Confezione	Imballo/Pz	8028274
EK0203	3	IP55	Bianco	Busta	1/10	...027433